

## Contents of the box:

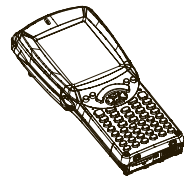

The WORKABOUT PRO



This Guide

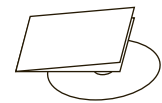

Additional documentation  
(dependent on order)

## Features: Front

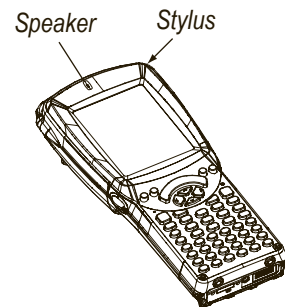

Speaker Stylus

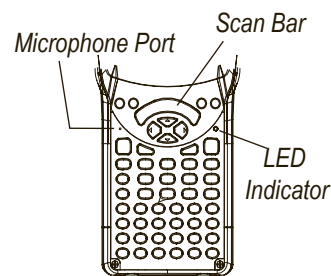

Microphone Port Scan Bar  
LED Indicator

## Features: Back and Ports

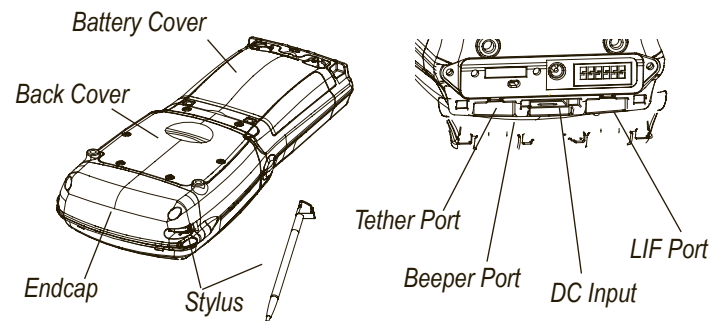

Battery Cover  
Back Cover  
Endcap Stylus  
Tether Port  
Beeper Port DC Input  
LIF Port

## Features: Typical Variants



Version without  
scanner or  
GSM radio



Version with GSM  
radio and scanner  
in endcap

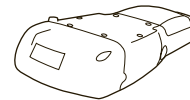

Version with scanner  
in endcap

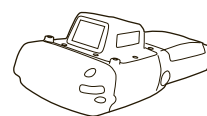

Version with scanner  
in pod

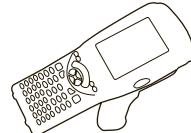

Version with pistol grip

## Features: The Battery Compartment

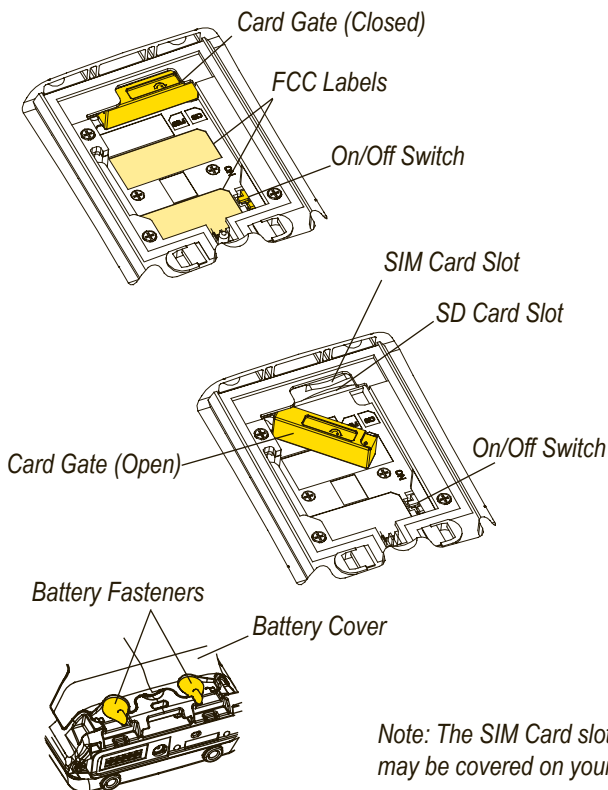

Card Gate (Closed)  
FCC Labels  
On/Off Switch  
SIM Card Slot  
SD Card Slot  
Card Gate (Open)  
On/Off Switch  
Battery Fasteners  
Battery Cover

Note: The SIM Card slot  
may be covered on your unit

## Getting Started

- 1 Switch the hardware on.

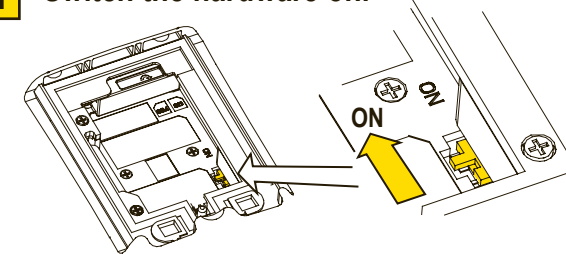

- 2 Insert the battery.

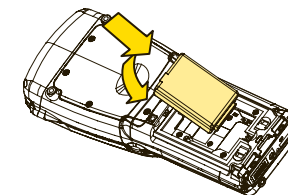

- 3 Close and lock the battery cover.

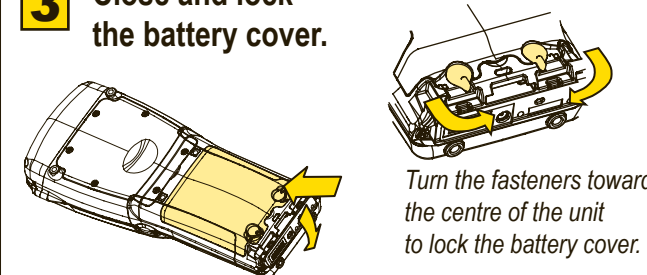

Turn the fasteners towards  
the centre of the unit  
to lock the battery cover.

Over

- 4 Charge the battery.** The power adaptor may be plugged directly into the WORKABOUT PRO.

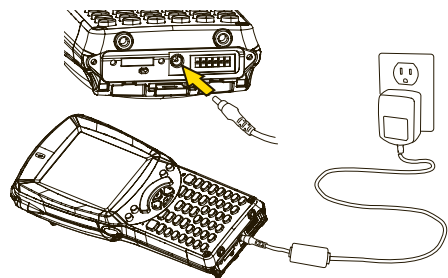

The WORKABOUT PRO may also be charged in a Docking Station.

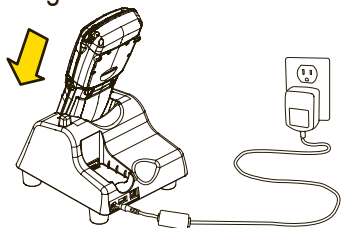

Note: Use only the universal AC power adaptor approved by Psion Teklogix for the WORKABOUT PRO.

Allow the WORKABOUT PRO to charge for 6 hours.

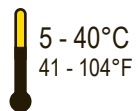

Note: Full battery performance is only reached after the first few full charge/discharge cycles.

- 5 Turn the unit on.** Press the Enter key for a few seconds.

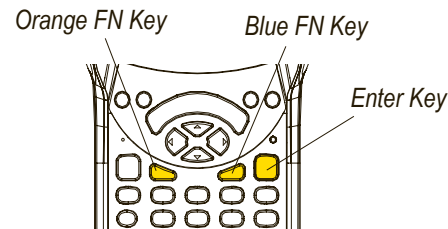

- 6 Connect the WORKABOUT PRO to the host computer.** Connect using a Tether Port to USB cable, or through a Docking Station.

- 7 Install ActiveSync®.** Go to <http://go.microsoft.com/fwlink/?LinkId=147001> and follow the instructions to download and install ActiveSync 4.5 or higher. Note: ActiveSync is not needed when connecting to a host computer that uses the Windows® Mobile Device Center (such as Microsoft® Windows Vista®).

- 8 Configure ActiveSync.** Follow the onscreen instructions provided by ActiveSync to establish a connection between the host computer and the WORKABOUT PRO.

To turn the WORKABOUT PRO off, do one of the following:

- Press and release the Blue FN key, then press and release the Enter key.
- Select **Shut down** from the **Start** menu.

### Resetting the unit

**Important:** Resetting may result in data loss.

To cold-reset the WORKABOUT PRO:

- Press the Blue FN key, the Orange FN key, and the Enter key simultaneously for a few seconds. The WORKABOUT PRO cold-resets. During a cold reset, running programs are halted and RAM memory is cleared. The contents of flash memory and the registry are preserved. The operating system is reloaded.

To warm-reset the WORKABOUT PRO:

- Press the Blue FN key and the Enter key simultaneously for a few seconds. The WORKABOUT PRO warm-resets. During a warm reset, running programs are halted. The contents of RAM, flash memory and the registry are preserved.



8000129-001

Rev. B

# WORKABOUT PRO

Hand-Held Computer  
C Version

## Quick Start Guide

July 14, 2009

PN: 8000129-001.B

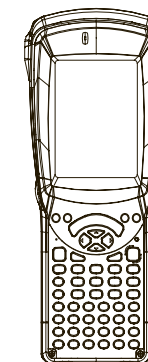

ISO 9001 Certified  
Quality Management System

